



“You’re Ahead With A Pitts Behind”

LB35-26

MAIN BEAMS

- ▶ Main longitudinal members 14" fabricated I-beam 100ksi yield

CAPACITY

- ▶ 35 tons in 16' length

ESTIMATED TARE WEIGHT (STANDARD PACKAGE)

- ▶ 15,000 ± 3%

LOAD BASE

- ▶ 16' rigid point load centered in deck

DIMENSIONS

- ▶ Overall: 8' 6" width x 45' length
- ▶ Clear deck length: 20', (double drop deck design)
- ▶ Deck height under full load: 26" (ground clearance: 12")
- ▶ 48" nominal loaded 5th wheel height

GOOSENECK DESIGN

- ▶ Fixed neck to deck connection
- ▶ Exposed main beams and recessed motor grader ramps
- ▶ 84" swing radius
- ▶ Toolbox in front of neck

DECK DESIGN

- ▶ Level deck design
- ▶ 1 1/2" nominal apitong
- ▶ (4) I-beam design

BOGIE DESIGN

- ▶ Wheel wells covered with formed steel check plate and traction bars
- ▶ 3' dovetail covered with steel check plate and traction bars
- ▶ 6' x 2' heavy duty spring assisted, self cleaning, rear loading ramps

AXLES

- ▶ (2) Heavy duty axles with 49" spread
- ▶ 25,000 lbs nominal capacity per axle (GAWR determined by suspension type, brakes, tires and other components)
- ▶ Tapered spindle axles

BRAKES

- ▶ 16 1/2" x 7"
- ▶ Heavy-duty brake drums, outboard mount
- ▶ Automatic slack adjusters
- ▶ Type 30/30 parking brakes on (2) axles

HUBS

- ▶ Hub-piloted 10-stud mount
- ▶ Outboard cast drums

WHEELS/TIRES

- ▶ (8) Steel disc wheels 8.25 x 22.5 with 255/ 70R 22.5 H-ply tires

SUSPENSION

- ▶ Hutch 9700 3 point heavy duty 4 leaf steel spring

ELECTRICAL SYSTEM

- ▶ Fully sealed wiring harness with LED lights
- ▶ Marker lights and mid-turn signals
- ▶ (3) Round stop, tail and turn lights per side on rear

PROTECTIVE COATING

- ▶ High quality 2-part polyurethane enamel
- ▶ High quality 2-part primer
- ▶ Blasted and cleaned prior to painting

LASH RINGS

- ▶ (8) Pair (16 total), bent D-ring

FLAG HOLDERS

- ▶ (2) Pair (4 total)

MODEL: LB35-26

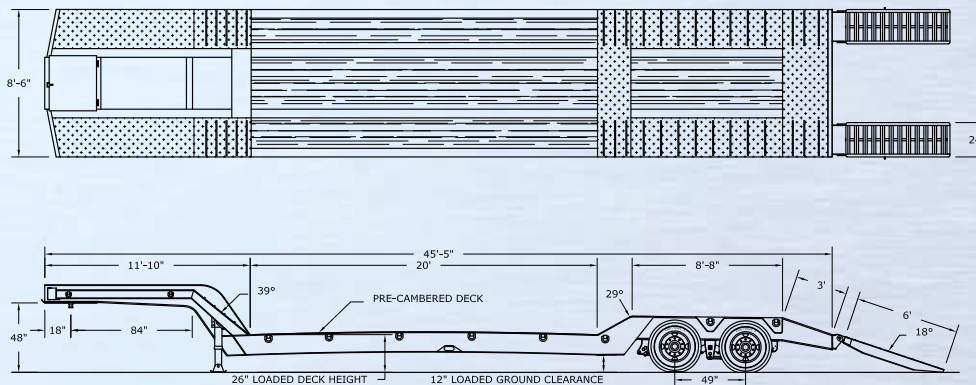

PITTSTRAILERS.COM

LEARN MORE ABOUT PITTS TRAILERS, AND JOIN US ON FACEBOOK

800.321.8073

PITTSVIEW, AL



Note: All specifications are subject to change without prior notification. All dimensions and weights are approximate. Trailers pictured in this brochure may feature optional equipment. copyright © 2013 Pitts Enterprises, Inc. (publ). Pate. All rights reserved.